

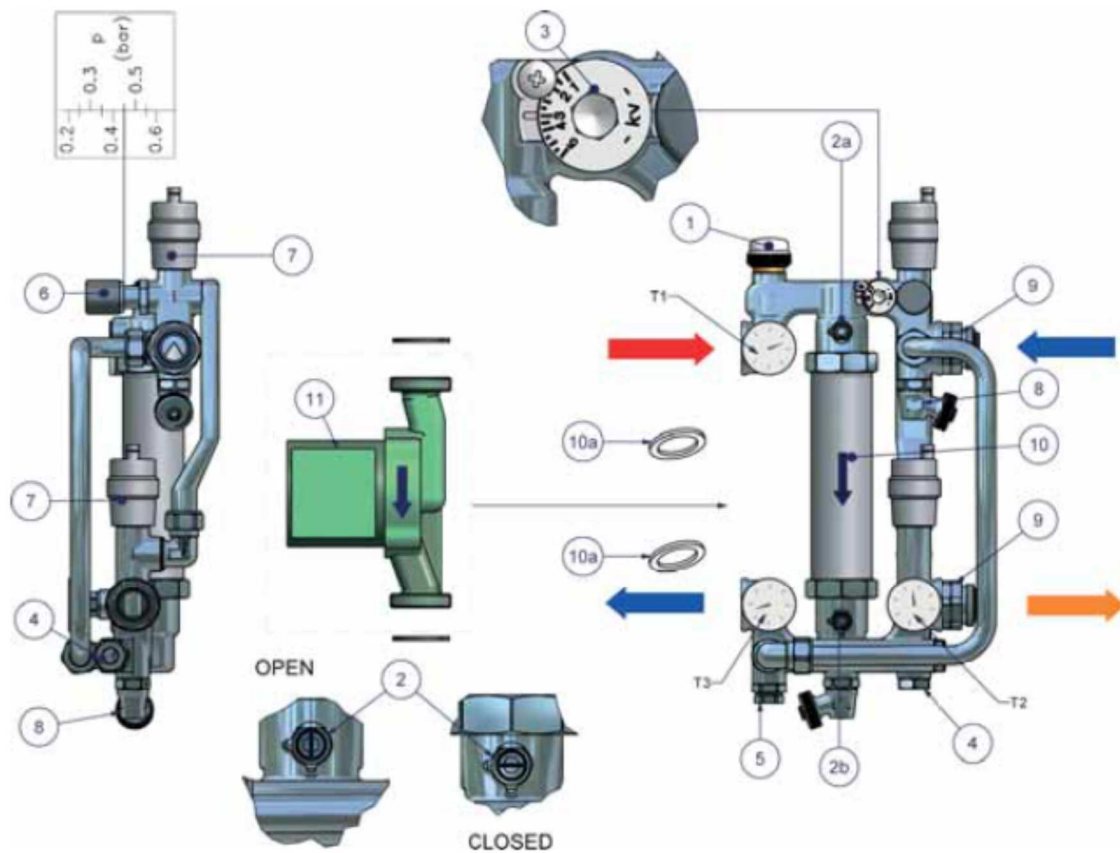









Polysan Festwertregelung



-  Absperrventil
-  Differentiales Bypassventil
-  Anschlusszubehor
-  Thermostat-Kopf mit eingebaute Steuerung und Eintauch-Fernfühler
-  Automatisches Entlüftungsventil
-  Kessel-Füll u. Entleerungs Kugelhahn („KFE“)
-  Fühler
-  Thermometer
-  Pumpe

